

18-40GHz High Power Amplifier

2022-9-25

Gain=45dB, Pout=+38dBm, 2.92mm Female

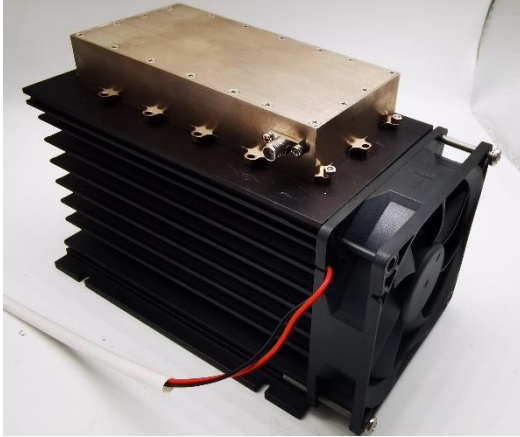

-HF Option with heatsink and Fan

Product Overview

AT-HPA-1840-4538GN is GaN Based high gain power amplifier with +38dBm output power in the frequency of 18-40GHz. The DC power requirement is +22V/3.5A at Psat. The module is with 2.92mm connector.

The power amplifier has high gain, high linearity, low input/output return loss and flat gain response. There is no heatsink and fan in default. Option with suffix “-HF” is part number with heatsink and Fan, -BT option is for bench-top system amplifier.

More information, please visit www.atmicrowave.com

Advantages

- ✓ Frequency: 18-40GHz
- ✓ Psat:+38dBm
- ✓ Small signal gain: 45dB
- ✓ Single Power Supply

Application

- ✓ 5G Communication
- ✓ Test Equipment
- ✓ ROF (RF Over Fiber)
- ✓ Radar System

Key Features

Parameter	Min	Typical	Max
Frequency		18-40GHz	
Gain	32dB	45dB	
P1dB		+34dBm	
Psat(18-39GHz)	+36dBm	+38dBm	
Drain Supply		+22V	+24V
Idd NO RF		2.5A	
IDD Psat		3.5A	4.2A
Input Return Loss		-10dB	
Output Return Loss(20-40GHz)		-7dB	
-HF Option Fan Vdd		20-26V	
Spec Temp		25C	





AT-HPA-1840-4538GN

18-40GHz High Power Amplifier

Mechanical Information

Item	Description
Input Port	2.92mm Female
Output Port	2.92mm Female
Case Material	Aluminum
Finish	Nickel Plated
Weight (Without Heatsink and Fan)	280g
Size:	See outline

Absolute Maximum Ratings Table

Parameter	Value
Drain Supply	+30V
RF Input Power	+16 dBm
Operating Temperature	-20 to +70C
Storage Temperature	-65 to +150C

Very Important:

1. MUST Apply to heatsink and Fan during operation, or the amplifier will be damaged due to the high power consumption;
2. Do NOT leave Output OPEN with Bias and input power. Connect to 50 Ohms system during operation.
3. Take care that Vdd never touch Case/GND when Power ON, or the amplifier will be damaged.





AT-HPA-1840-4538GN

18-40GHz High Power Amplifier

Part Number Selection

Item	Description
AT-HPA-1840-4538GN	In defaulted without heatsink and Fan. Heatsink and Fan required during operation.
AT-HPA-1840-4538GN- HF	Including Heatsink and Fan. Fan bias is same with Vdd normally.
AT- BT HPA-1840-4538GN	Bench-top System Amplifier, 90-220V AC Power Supply Please note gain will be 1-2db lower than standard module, while Pout will keep the same. Please contact with us for more information.



In default
without heatsink

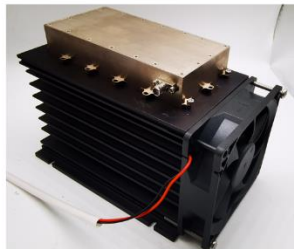

-HF Option
With Heatsink and Fan



-BT Option
Bench-top System Amplifier



Test Data (25C)

Please note that test curves will vary slightly from unit to unit.

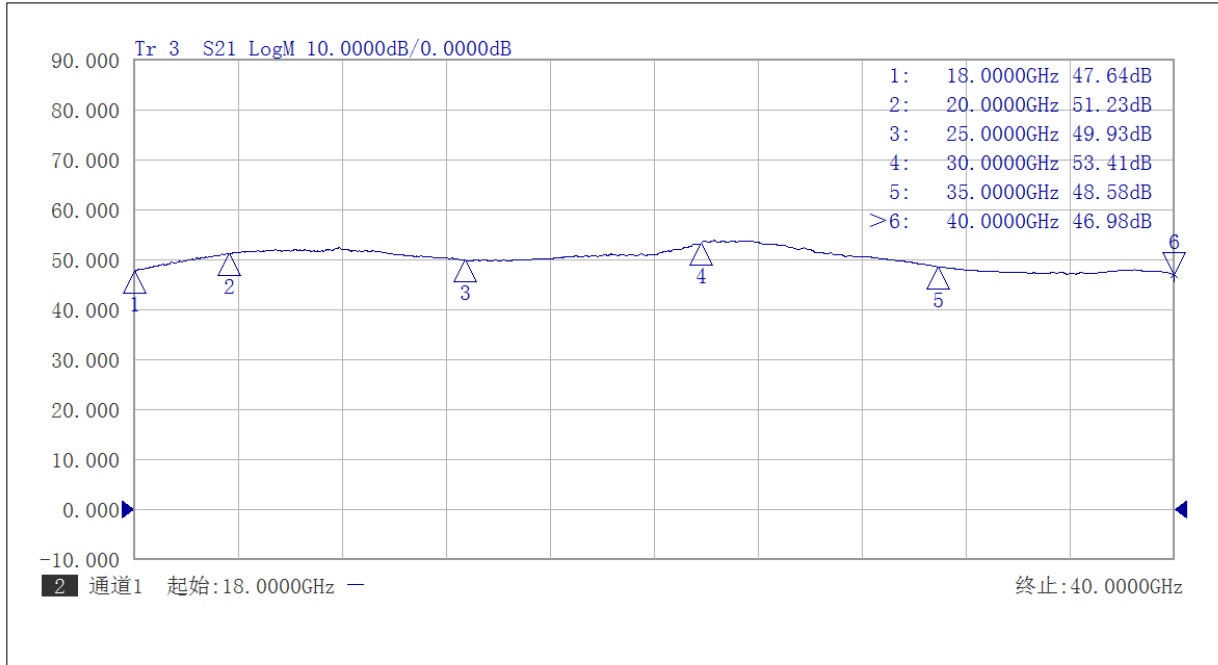

Gain vs Frequency

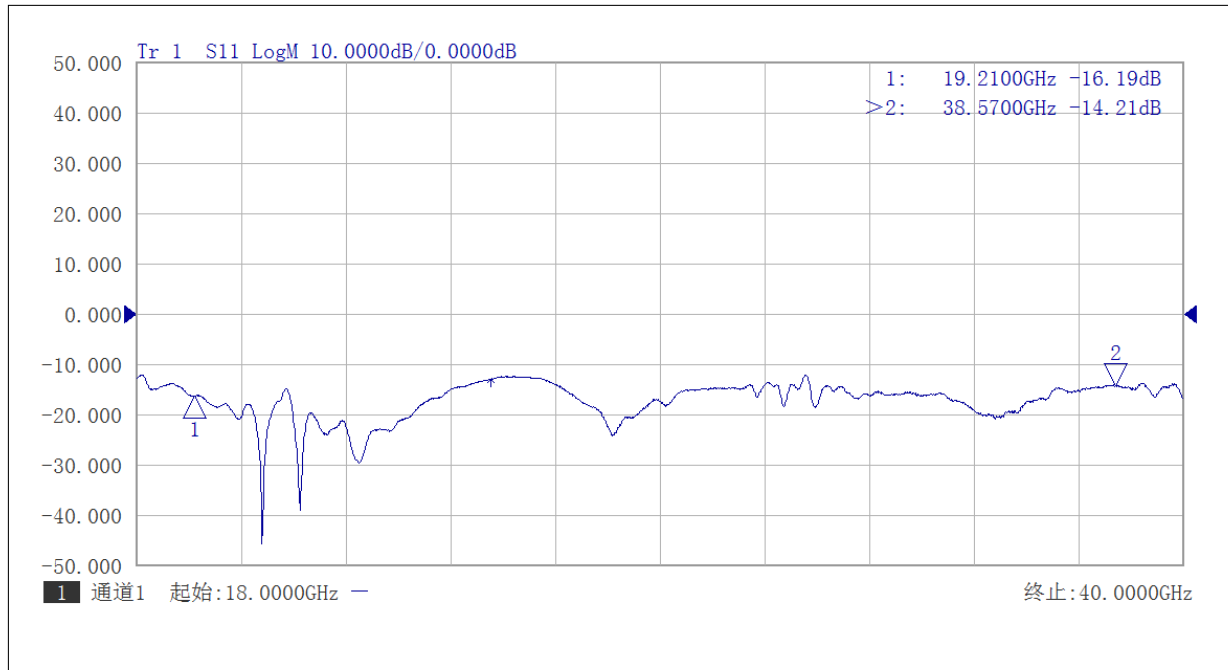

Input Return Loss vs Frequency



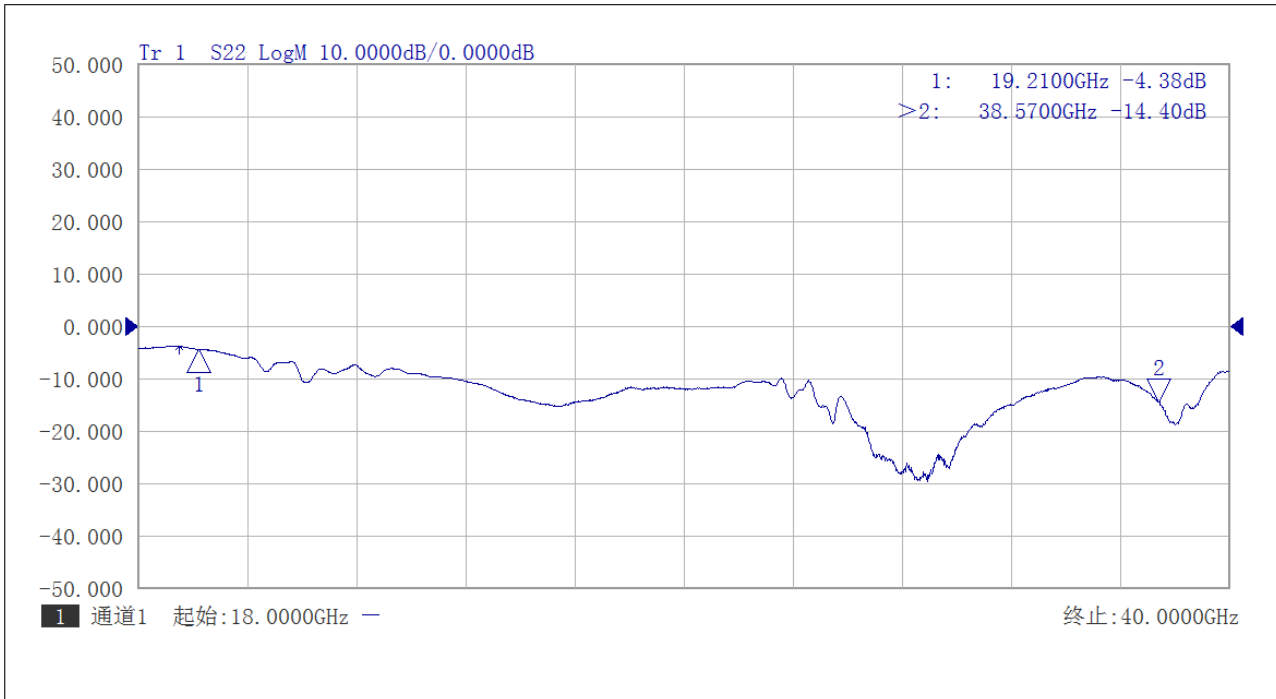

Output Return Loss

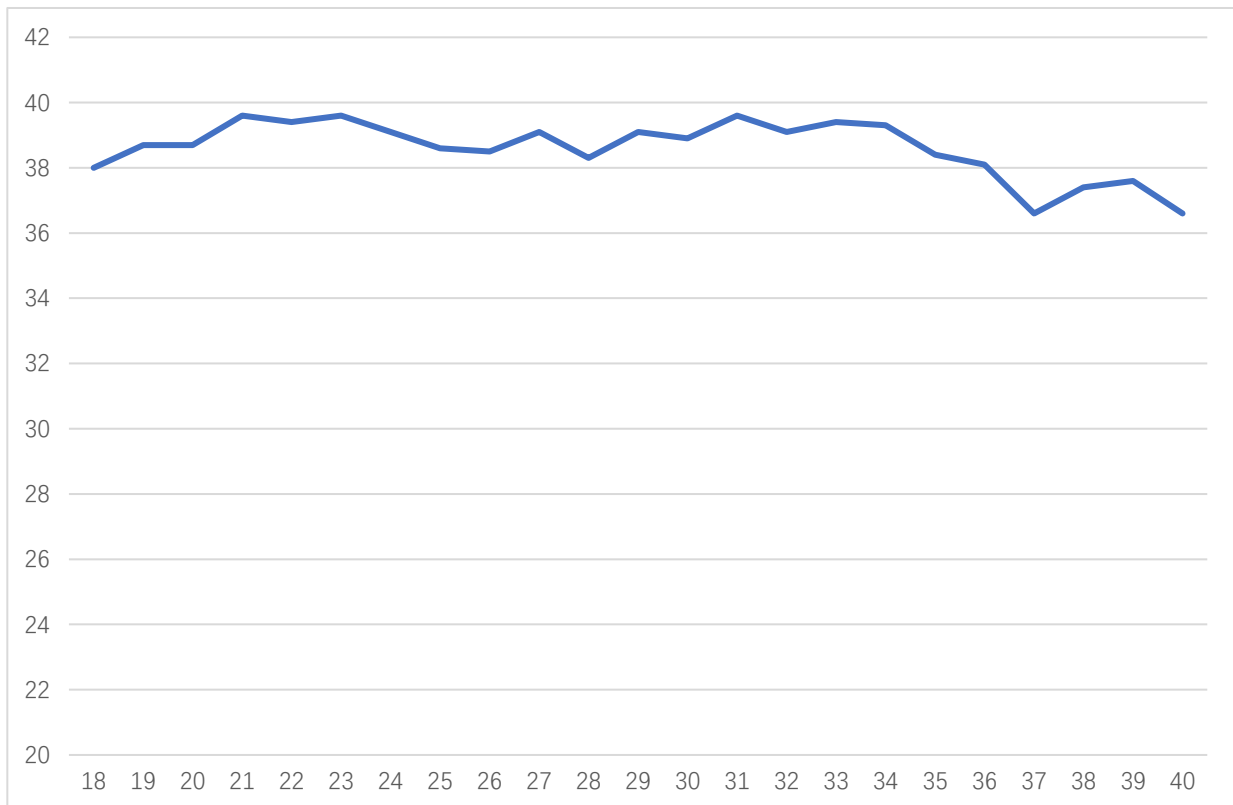

Psat vs Frequency



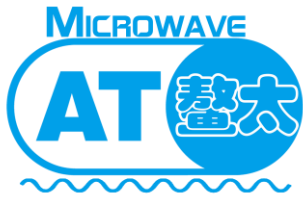

AT-HPA-1840-4538GN

18-40GHz High Power Amplifier

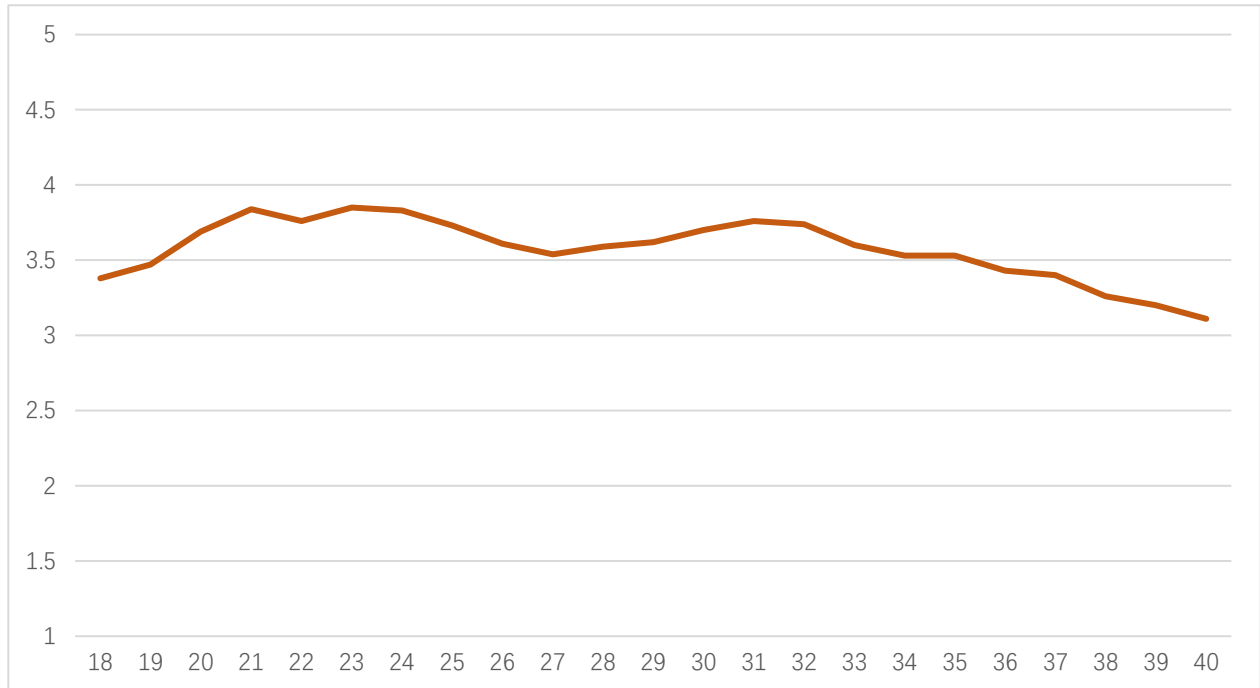

IDD vs Frequency

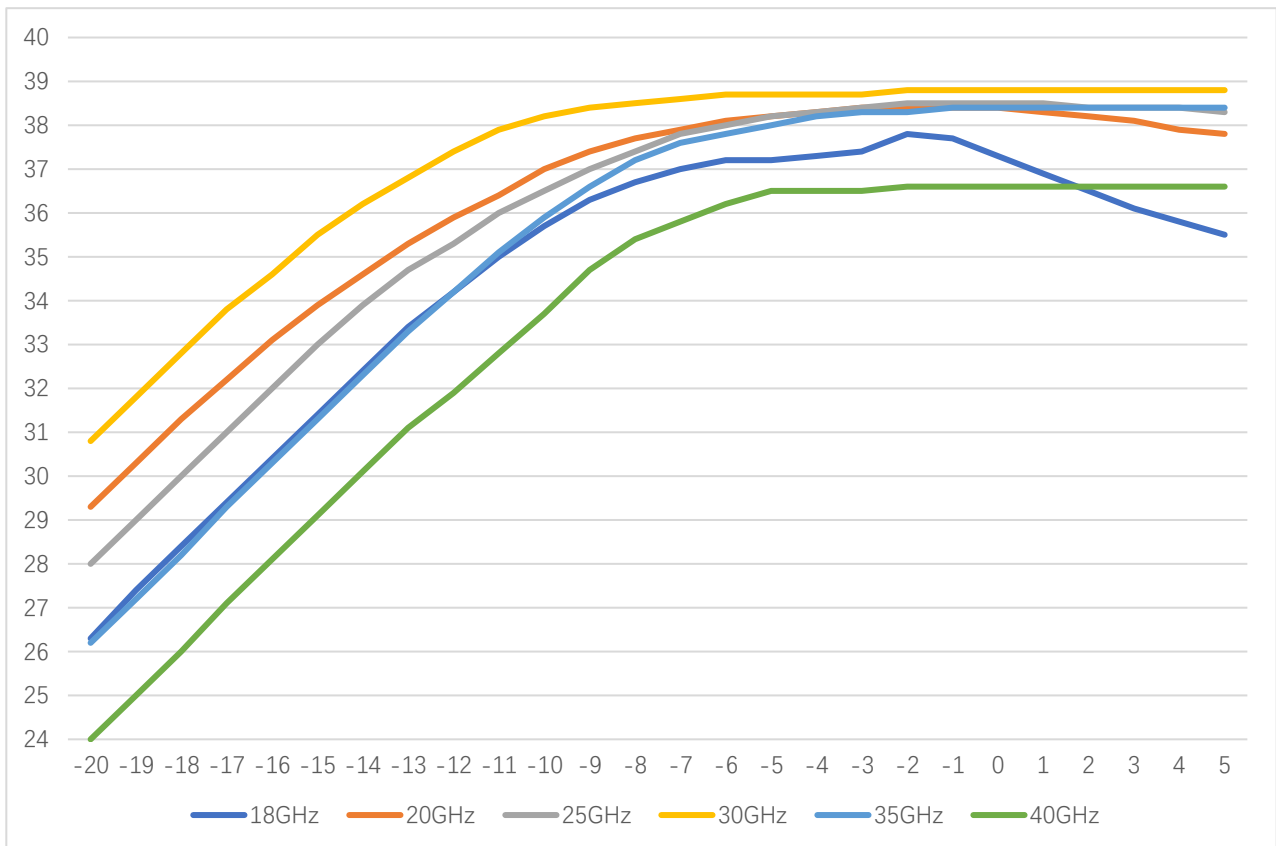

Pout vs Pin



Standard Module Outline Without Heatsink: (mm)

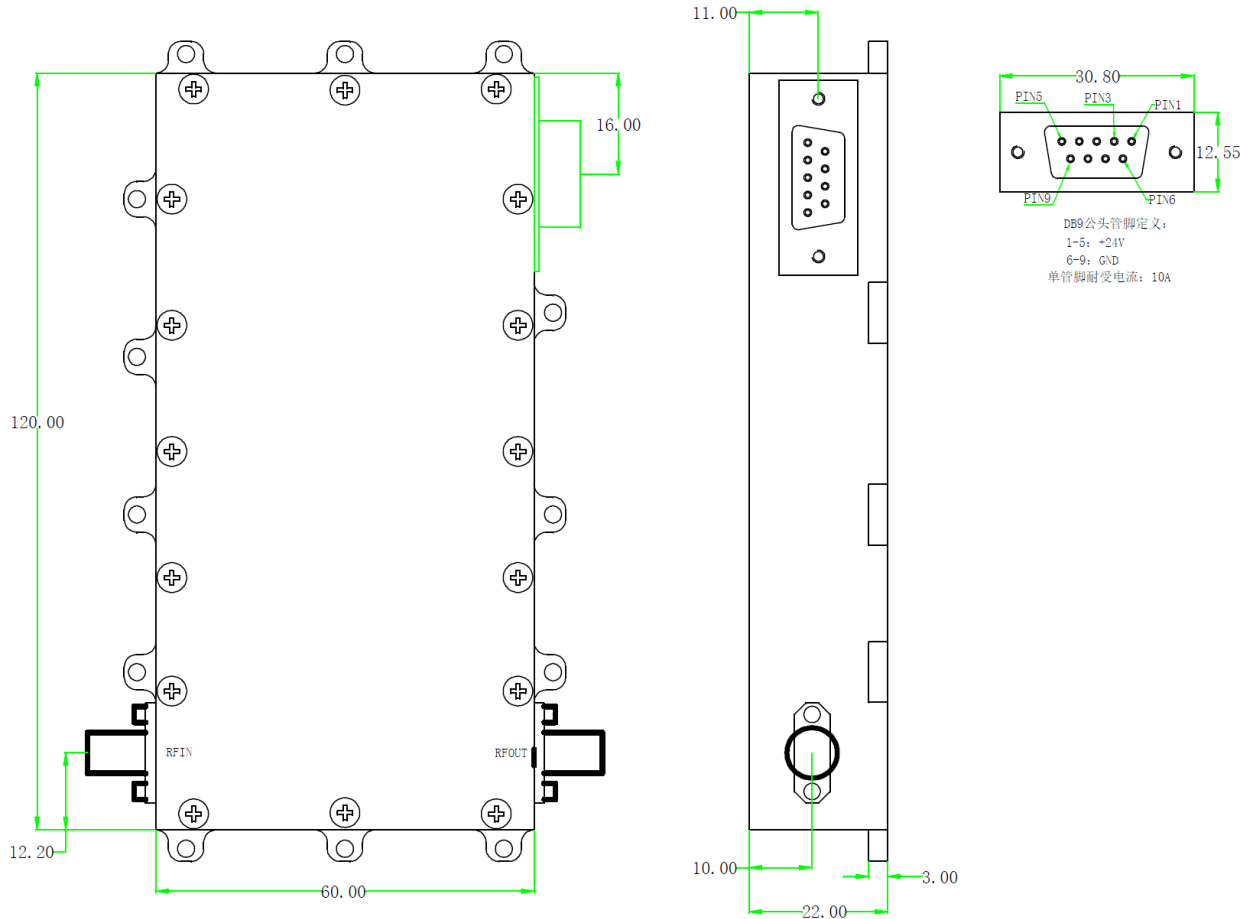

PA Module without heatsink and Fan

Heatsink and Fan Required during Operation



-HF Option:

Module With Heatsink and Fan: (mm)

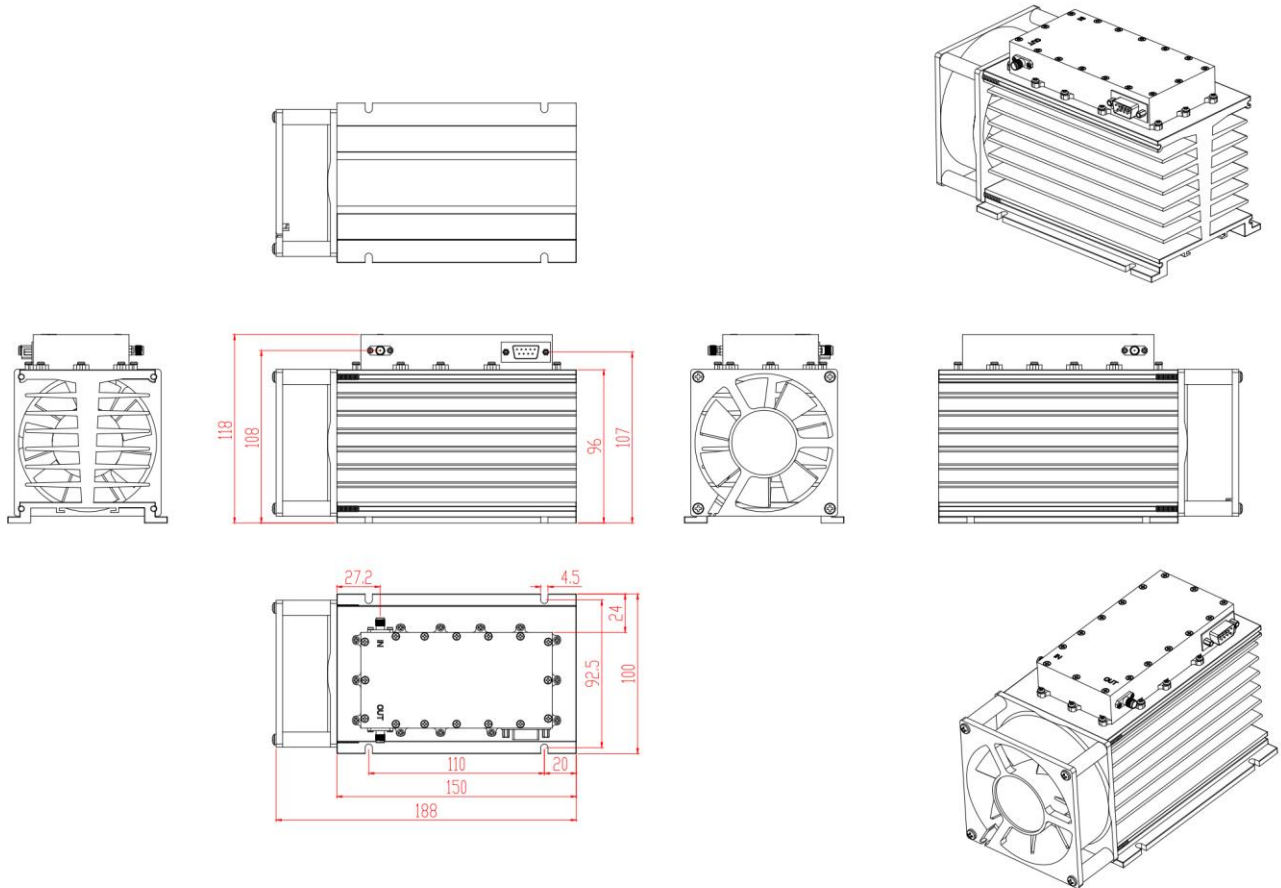

Customers can remove the heatsink and Fan if using their own heatsink.



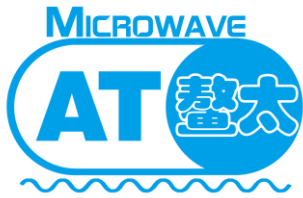

AT-HPA-1840-4538GN

18-40GHz High Power Amplifier

-BT Option,

Bench-top outline System Amplifier: (mm)

